



Cimarron® Comfort Height®

Two-piece elongated 1.28 gpf chair height toilet
K-5310-RA

Features

- Two-piece design.
- Elongated bowl offers added room and comfort.
- Skirted trapway simplifies cleaning.
- Comfort Height® feature offers chair-height seating that makes sitting down and standing up easier for most adults.
- 1.28 gpf (4.8 lpf).
- Right-hand Polished Chrome trip lever.
- 2-1/8" (54 mm) fully glazed trapway.
- Patented ReadyLock™ installation system, a simple solution for skirted toilets, saves time, hassle, and eliminates the need to drill into the floor for standard 12" (305 mm) rough-in.
- Combination consists of the K-5309 bowl and the K-4369-RA tank.
- Coordinates with other products in the Cimarron collection.

Technology

- Single-flush gravity uses the force of gravity and a precision-engineered tank, bowl, and trapway to create a strong siphon during flushing.
- AquaPiston® canister allows water to flow into the bowl from all sides (360°), increasing the power and effectiveness of the flush.
- Flush valve's 3:2 ratio harnesses the natural force of gravity and optimizes flush performance.
- Durable canister design has 90% less exposed seal material than a 3" flapper for leak-free performance.
- Light-touch canister flush requires a lower actuation force than a flapper.
- AquaPiston® canister flush valve optimizes flush performance and resists warping and deterioration.

Installation

- Kohler's innovative installation system offers easy, intuitive installation with no need to drill holes in floor.
- Standard 12" (305 mm) rough-in; 10" (254 mm) and 14" (356 mm) rough-in kits also available.
- Seat and supply line sold separately.

Water Conservation & Rebates

- Eligible for consumer rebates in some municipalities.

Recommended Products/Accessories

- K-4008 Reveal® Quiet-Close™ Elongated Toilet Seat
- K-4108 C³®-230 Elongated bidet toilet seat
- K-7637 Angle Supply with Stop (single)
- K-5383 10" Rough-in Full Skirt Trap and Attachment System
- K-5381 14" Rough-in Full Skirt Trap and Attachment System
- K-9466-R Right-Hand Trip Lever
- K-4636 Cachet® Quiet-Close™ Elongated Toilet Seat
- K-5588 Purefresh® Elongated Toilet Seat



ADA CSA B651 OBC

Codes/Standards

- ASME A112.19.2/CSA B45.1
- DOE - Energy Policy Act 1992
- EPA WaterSense®
- California Energy Commission (CEC)
- ADA
- ICC/ANSI A117.1
- CSA B651
- OBC

KOHLER® Toilets and Seats Limited Warranty

See website for detailed warranty information.

Available Colors/Finishes

Color tiles intended for reference only.

Color	Code	Description
	0	White
	96	Biscuit

1-800-4KOHLER (1-800-456-4537)

Kohler Co. reserves the right to make revisions without notice to product specifications.

For the most current Specification Sheet, go to www.kohler.com.

8-7-2021 05:08 - US/CA

THE BOLD LOOK
OF **KOHLER**®

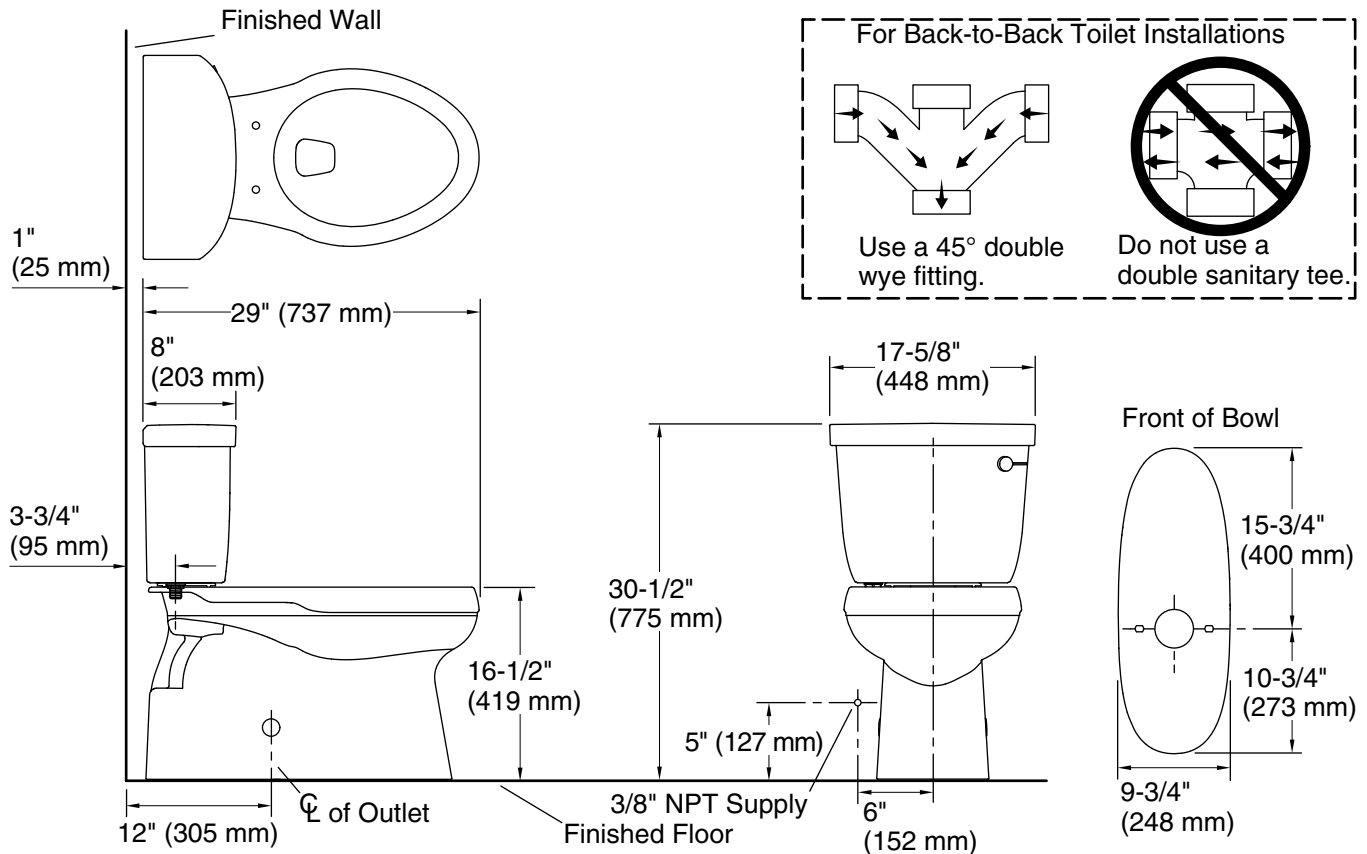

Technical Information

All product dimensions are nominal.

Toilet type:	Two-piece, Floor-mount
Waste Outlet:	Floor
Trap passageway:	2-1/8" (54 mm)
Water Consumption	
Full:	1.28 gpf (4.8 lpf)
Water surface size:	9-5/8" x 6-5/8" (244 mm x 168 mm)
Rim to water surface:	6-3/8" (163 mm)
Rough-in:	12" (305 mm)

Fixture Supply Requirements

Min static pressure: 15 psi (103.4 kPa)

Notes

Install this product according to the installation instructions.

For back-to-back toilet installations: Use only a 45° double wye fitting.

ADA, OBC, CSA B651 compliant when installed to the specific requirements of these regulations.

Plumbing codes may require elongated toilets and elongated, open-front seats in public bathrooms.

Accessibility standards may require controls to be located on the open side of the toilet.